

PARTS LIST, INSTALLATION AND GENERAL INFORMATION

LS-900

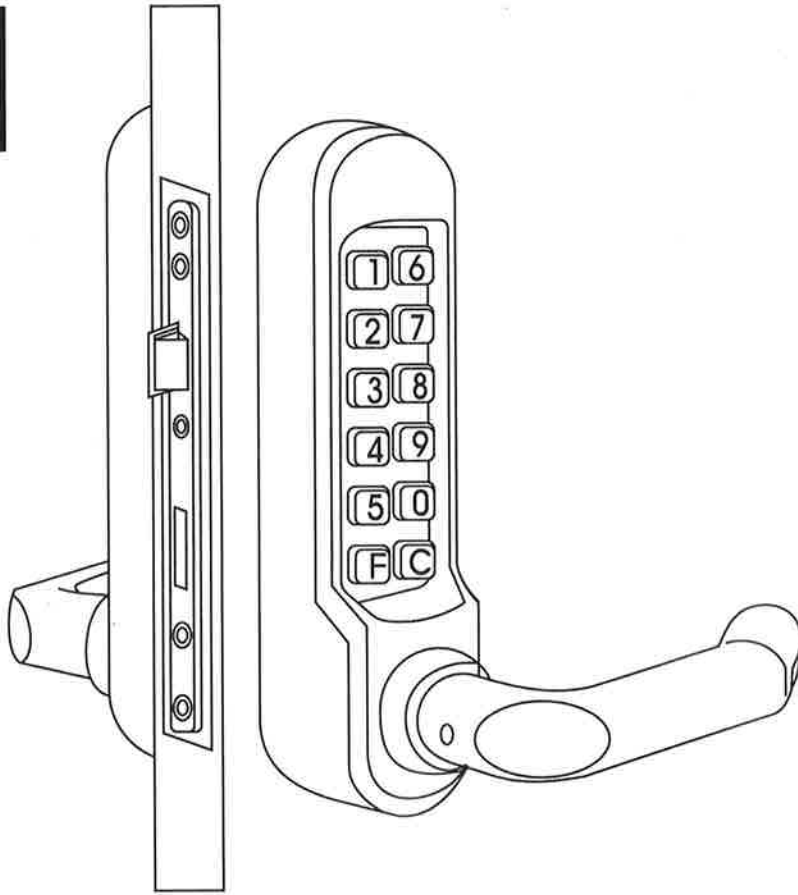

PARTS LIST

Please make sure you have received the following parts:

- (1) Outside lock mechanism
- (2) Inside lock mechanism
- (3) Accessories in 4 packs
- (4) 1 Long & 2 short hexagonal screwed posts are already fitted to back of outside lock mechanism

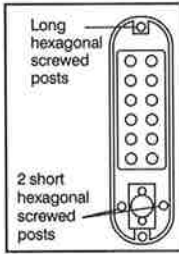

ACCESSORIES PACK 2

- Escutcheons
- 4 screws

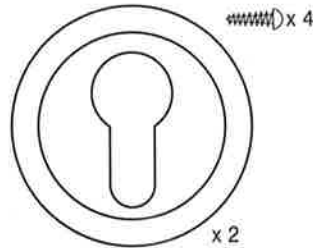

ACCESSORIES PACK 1

- 2 spindles - 8mm square and 7mm square
- 1 spindle collar
- 1 lock pin for locking the collar and the spindle together

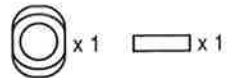

ACCESSORIES PACK 3

- 2 non-coded tumblers
- 2 M4X36 screws
- 1 long hexagonal shaft
- 2 coded tumblers
- 2 M4X51 screws
- 1 hexagonal key
- 1 Tweezer

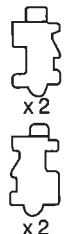
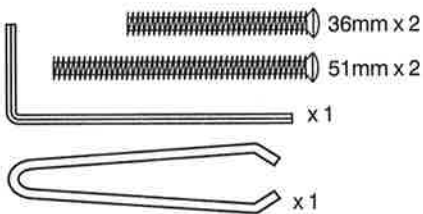

INSTALLATION

1. ESTABLISH THE "HAND" OF THE DOOR.

Viewing from OUTSIDE it is right hand if the hinges are fitted on the right and it is left hand if the hinges are fitted on the left-hand side of the door. This is regardless of whether the door swings inward or outward.

2. INSTALLATION

APPLY THE TEMPLATE

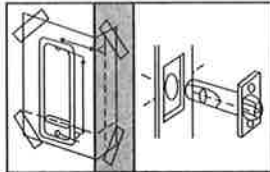

Tape the template to the door. Make sure that you fold it along the appropriate line, depending on the backset of the latch (60mm Or 70mm).

Mark and drill all six 10mm holes.

Use a chisel to clear the line of 4 x 10mm holes into a single slot

POSITIONING AND FIXING THE LATCH

Mark a central point on the 'centre line of latch' on the door edge.

Drill a 28mm hole x 88mm deep.

Insert the latch into the hole, and draw around the face plate.

Remove the latch and cut a 3mm rebate so that the face plate will fit flush with the door.

Secure the latch with the wood screws.

3. BEFORE FIXING.

Please check that the LS-900 series is working correctly by entering the code. remembering to press the "C" button first.

4. FREE ACCESS FEATURE

To activate the free access feature, follow the procedure:

- A) enter the correct code
- B) press the "F" button
- C) press the handle down fully to open the door

To de-activate the free access feature

- A) press the "F" button
- B) press the "C" button fully down

SPINDLE ASSEMBLY (diag.1)

- a) Choose the correct size spindle according to the size of the follower of the lock case.
- b) Slide the spindle collar onto the rounded end of the spindle and lock it in place with the lock pin provided.

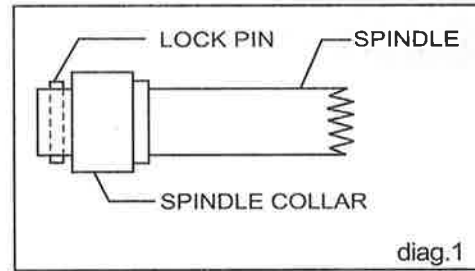

INSTALLING THE SPINDLE ASSEMBLY INTO THE OUTSIDE LOCK MECHANISM (diag.2)

(diag.2)

With the back of the outside lock assembly facing you.

- a) Unscrew the 2 screws A and B
- b) Remove the cover C
- c) Place the spindle assembly into the slot under cover C
- d) Replace cover C
- e) Secure cover C with screws A and B

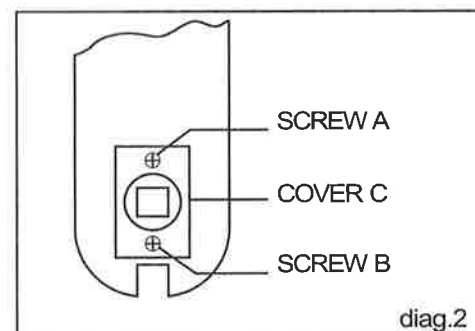

CHANGING THE HAND OF THE LOCK

RIGHT HAND DOOR (diag.3)

The lock is pre-set for Right hand door

With the back of the outside door mechanism facing you

- a) Turn the spindle clockwise fully.
- b) Slide the spindle through the follower of the lock case.

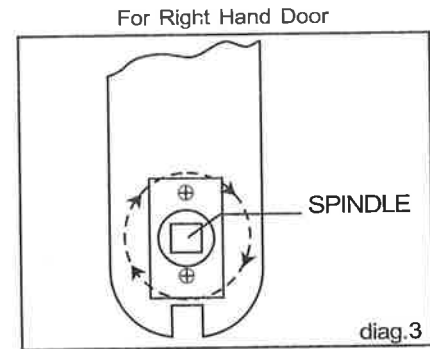

LEFT HAND DOOR

OUTSIDE LOCK MECHANISM (diag.4)

With the back of the outside door mechanism facing you

- a) Turn the spindle counter clockwise fully.(diag.4)
- b) Slide the spindle through the follower of the lock case.

"IF REMOVING THE GRUB SCREW FOR ADJUSTMENT OR TO REVERSE THE HAND PLEASE ENSURE IT IS REPLACED.AND TIGHTENED UP FULLY "

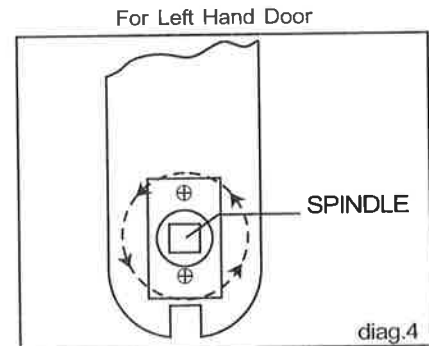

INSIDE DOOR MECHANISM (diag.5)

With the back of the inside lock mechanism facing you

- a) Unscrew the 4 screws marked.
- b) Swing the handle to the other side.
- c) Tighten the 4 screws back into the original position.

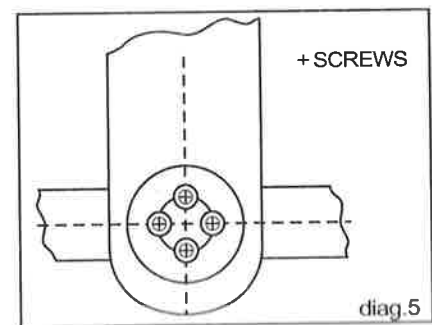

HANDING

Rules

1. The hand of a door is always determined from the outside.
2. The outside of an exterior door is the street or entrance side.
3. The outside of an auditorium door is the corridor or hall side.
4. The outside of a room door is the corridor or hall side.
5. The outside of a closet door is the room, corridor or hall side.
6. The outside of a single communicating door is the side from which the butts are invisible when door is closed.
7. The outside of twin communicating doors is the space between the two doors.

HANDING CHART

(Always take hand from outside)

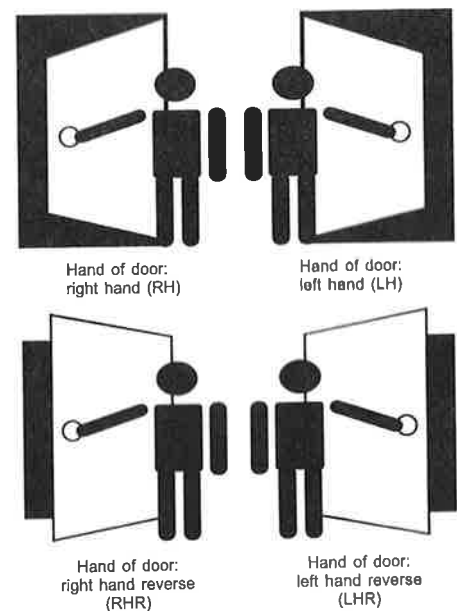

GENERAL INFORMATION

CHANGING THE ACCESS CODE

Your lock has been pre-programmed with a four-digit access code. This section tells you how this code may be changed.

You will also have been supplied with spare tumblers; these may be used to reduce the code to five digits.

Also supplied is a pair of tweezers for removing the tumblers. Make sure these are ready to hand.

(1) Remove the main body of the lock from the door.

(2) Place the lock body face down on a firm, flat surface, and remove the four screws securing the back plate. Take care at this stage, as there are many small parts that might become loose.

(3) Removing the back plate will reveal lock tumblers in two columns of Six - 4 red, 6 blue one "F" button and one "C". Red tumblers relate to the code; blue tumblers are 'nul'. The clear tumbler is activated by the 'C' button, the free access is activated by the "F" button AND SHOULD NEVER BE REMOVED.

(4) Tumblers are freed by pressing the 'C' button, when they may be withdrawn using the tweezers provided. Transposing red and blue tumblers in the lock will change the existing five-digit code; exchanging red and blue tumblers from the 'spares' provided will alter the number of digits used in the code.

PLEASE NOTE that tumblers must be correctly positioned, according to the 'column' in which they are placed. (See drawing below).

(5) When you have completed your changes, make a note of the new code!

(6) Reassemble back plate - satisfy yourself that the new code operates as expected.

(7) Re-fit lock to door. Once again, test the new code before closing the door.

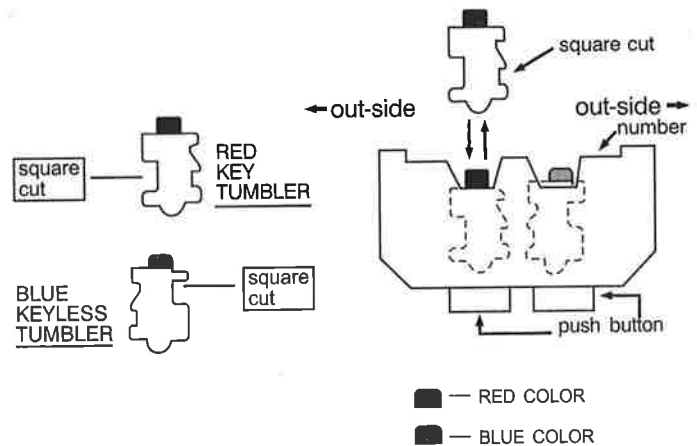

SUPPLEMENTARY INSTRUCTIONS FOR 900 SERIES

LEFT HAND DOOR

Outside Lock Mechanism

- a. Remove the rubber cover (1) at the side of the handle.
- b. With the hexagonal key provided, loosen the grub screw (2) at the side of the handle until the handle can be removed.
- c. Slide the handle out from the holder and refit the handle to the left side.
- d. Tightened the grub screw.
- e. Replace the rubber cover.

1
—
—
—

1. Rubber cover
2. Grub screw
3. Handle
4. Handle holder
5. Outside Lock Mechanism

Warning

In some situation, The operation of the handle will become sluggish when it has been removed and refitted. When this occurs, operate handle continuously by engaging the “ F ” function until the handle returns to its original position smoothly

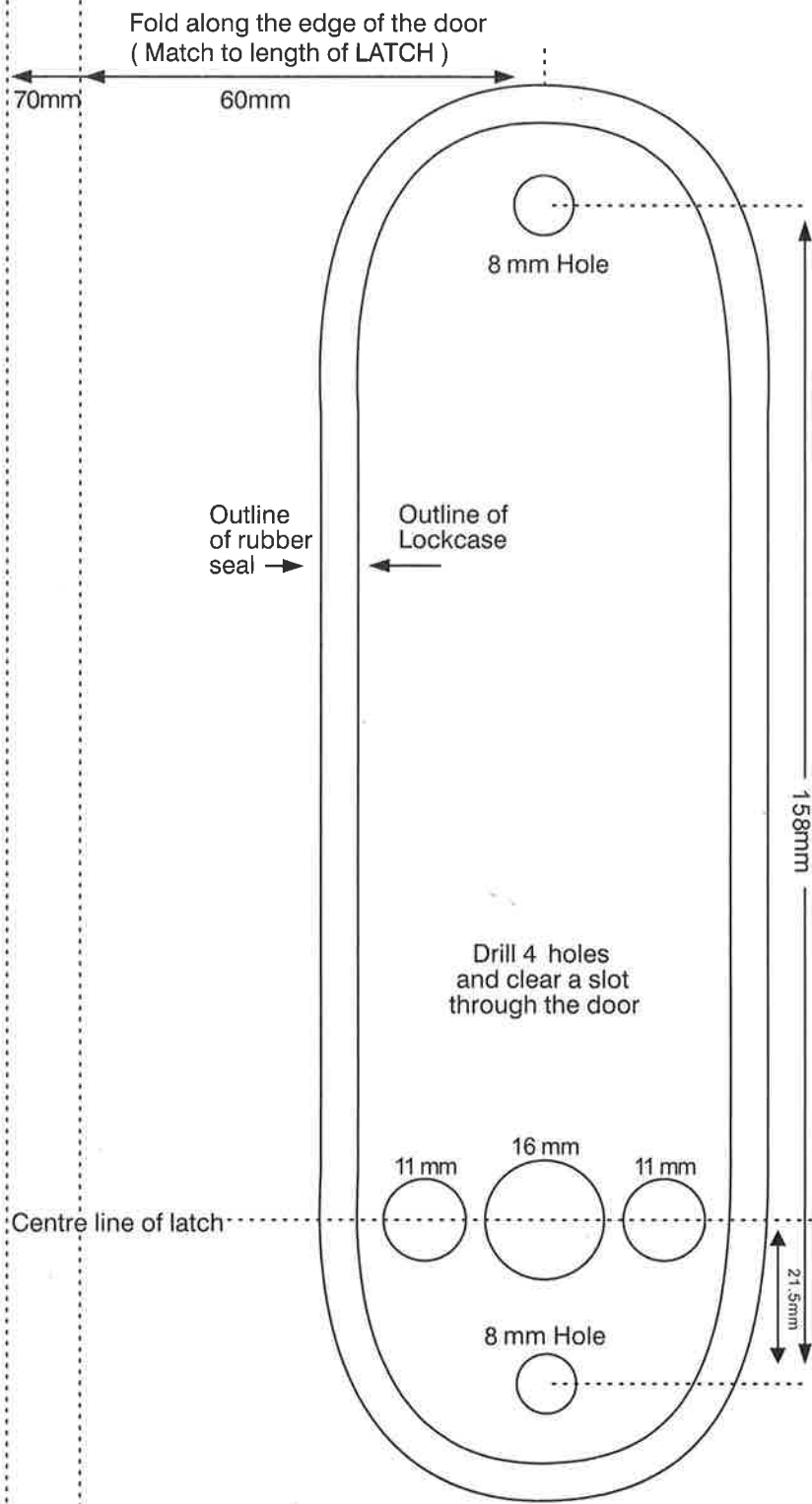

TEMPLATES

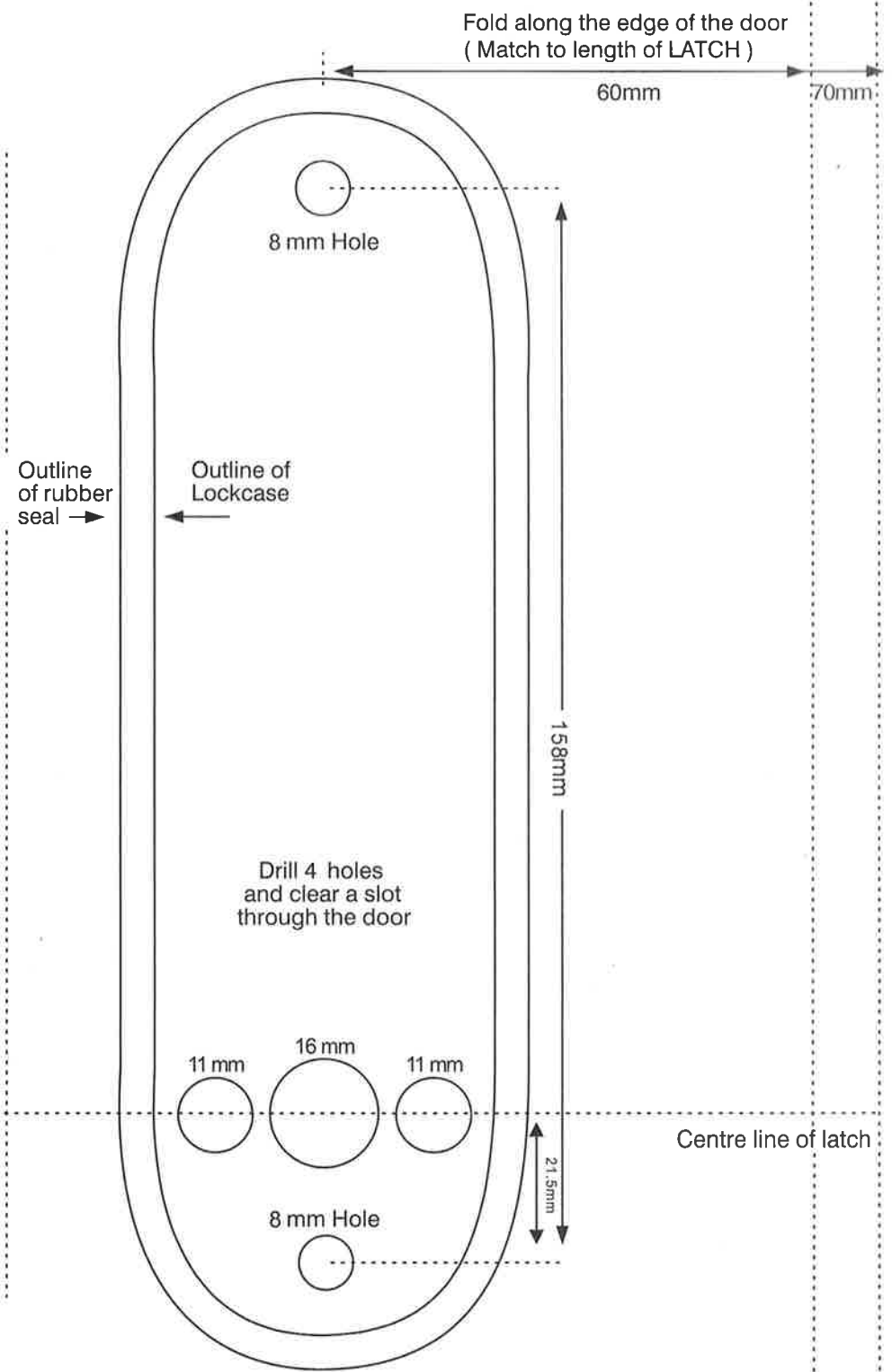

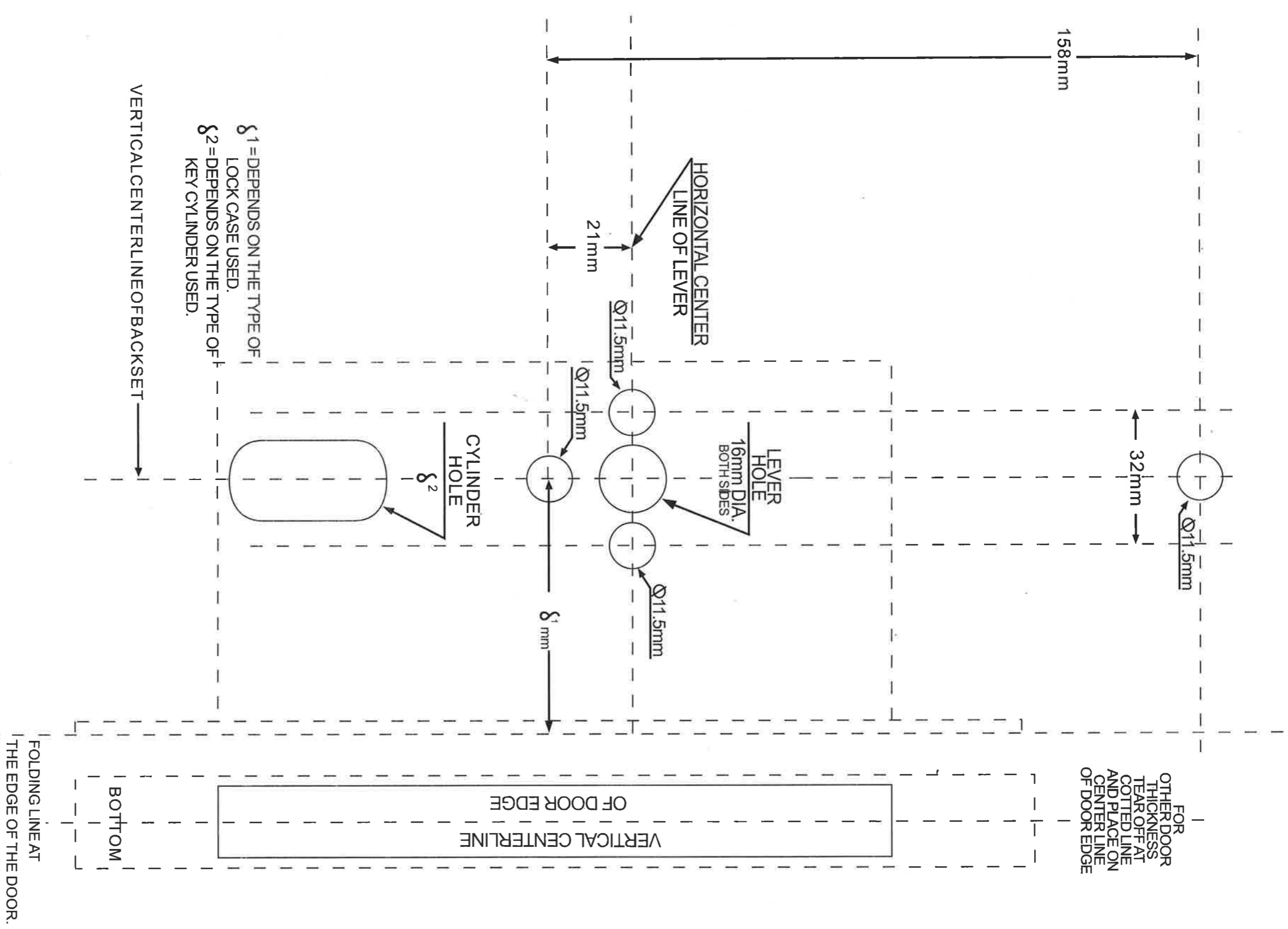

§ 1 = DEPENDS ON THE TYPE OF LOCK CASE USED.
 § 2 = DEPENDS ON THE TYPE OF KEY CYLINDER USED.